

## MAGICFX<sup>®</sup> CO2 JET



PRODUCT CODE : MFX1101  
VERSION : 1.0  
DATE : 14.12.2012



## 1. CONGRATULATIONS!

You have bought a great new product from MAGICFX®.

MAGIC FX is a Dutch manufacturer of professional special effects machines and equipment. We have been experts in special effects since our establishment in 1995. All our products are made under the brand name MAGICFX® which by now has acquired a great reputation on account of its quality and reliability. All products are made in accordance with the European Machinery Directive. MAGIC FX manages the entire production process in-house, from the design stages and prototyping to production. In short, we cover everything from concept to ready-to-use product.



Moreover, MAGIC FX is Europe's largest supplier of high-quality and fireproof confetti products and streamers. Thanks to our very large stock levels, we can deliver quickly and at low prices.

MAGICFX® is used by special effects professionals all over the world and our products are distributed through a dealer network which covers more than 80 countries.

Congratulations and enjoy your purchase!

# MAGIC:CFX®

## 2. CE MARKING

	<p><b>PLEASE NOTE:</b> We presume that you, your employees and others who use or come into contact with the machine are familiar with how the machine must be dealt with. This includes the correct use, maintenance and repair of the machine as described in this user manual. This also means that the employees are familiar with the use of machines through training or experience.</p>
	<p><b>DANGER WARNING:</b> Only use the CO2 Jet in accordance with the regulations and instructions in this manual. Consult MAGIC FX in case of doubt.</p>

Disclaimers:

MAGIC FX B.V. excludes liability for unsafe situations, accidents and damage that are the result of:

- Disregard for the warnings or regulations as set out on the CO2 Jet or in this documentation.
- Use for other purposes or under other circumstances than those set out in this documentation.
- Alterations to the CO2 Jet. This also includes the use of replacement parts other than the original ones.
- Insufficient maintenance.
- Unauthorised removal of safety caps and/or safeguards.
- Incompetent operation of the machine.

MAGIC FX B.V. is not liable for any consequential loss in the event of a CO2 Jet breakdown.

© Copyright 2012

All rights are reserved. Nothing from this manual may be duplicated, or kept in an automated data file, or made public, or in any form or manner, whether electronically, mechanically, by photocopying, by incorporation, or in any other manner duplicated without the permission of MAGIC FX B.V.

MAGIC FX at all times retains the right to make alterations without the direct knowledge of the client. The contents of this user manual can also be changed.

Please contact the technical department of your supplier for extra information with regard to, for example, maintenance and repair. This user manual has been drawn up with the utmost care. MAGIC FX cannot be held responsible for any mistakes made in this publication or for any consequences thereof.

### 3. DECLARATION OF CONFORMITY

---

**DECLARATION OF CONFORMITY**  
(according to Annex II.1.A of the Machinery Directive)



Concerning the Machinery Directive.  
We; MAGIC FX B.V.  
Schouwrooij 27  
5281 RE Boxtel  
The Netherlands

State under personal responsibility:  
We are the manufacturer of the product:

**MF1101 - MAGICFX® CO2 Jet**

to which this statement relates and which is in accordance with the provisions of the following Directive(s):

- Machinery Directive 2006/42/EC
- Low Voltage Directive 2006/95/EC
- EMC Directive 2004/108/EG
- Pressure Equipment Directive 97/23/EC

The following harmonising standards have been applied:

- NEN-EN-ISO 12100
- NEN-EN-ISO 60204-1

Place : Boxtel  
Date : 18-10-2012

Name: MAGIC FX

A handwritten signature in black ink, appearing to be 'B. Veroude', is written over a horizontal line. The signature is stylized and includes a large circular flourish on the left side.

Director: B. Veroude





## 4. FOREWORD

This manual describes the MAGICFX® CO2 Jet. The information in this manual is important for the proper and safe functioning of the CO2 Jet. If you are not familiar with the installation, operation, preventative maintenance etc. of the CO2 Jet then please read this user manual carefully from beginning to end. MAGIC FX also insists that all new users (operators, installers, maintenance workers and cleaners) receive a training course in which this user manual can serve as a starting point.

MAGIC FX advises that the original of this user manual, including appendices, is kept at a safe and central place. It is best that another original or copy is kept close to the CO2 Jet at the workplace.

If you are familiar with these matters, then you can use this manual as a work of reference.

The following standard markings are used in this manual for drawing attention to certain subjects or actions.

	<p><b>TIP:</b>  <b>Gives you suggestions and advice regarding easier or more convenient ways to carry out certain tasks.</b></p>
	<p><b>PLEASE NOTE:</b>  <b>A comment with additional information: alerts you to certain problems.</b></p>
	<p><b>CAUTION:</b>  <b>The machine can be damaged if you do not follow the procedures carefully.</b></p>
	<p><b>DANGER WARNING:</b>  <b>You can get (seriously) hurt if you do not carefully carry out the procedures.</b></p>

## CONTENTS

1.	CONGRATULATIONS! .....	1
2.	CE MARKING.....	2
3.	DECLARATION OF CONFORMITY .....	3
4.	FOREWORD .....	4
5.	INTRODUCTION .....	6
5.1	DESCRIPTION AND APPLICATION OF THE CO2 JET .....	6
5.2	NECESSARY ACCESSORIES.....	6
6.	SAFETY .....	7
6.1	INTRODUCTION .....	7
6.2	GENERAL SAFETY RULES.....	7
6.3	WARNINGS.....	7
7.	PARTS .....	9
8.	ACCESSORIES.....	10
9.	PREPARATIONS .....	10
10.	INSTALLATION .....	11
11.	USAGE .....	14
12.	SWITCHING OFF .....	15
13.	TROUBLESHOOTING .....	16
14.	TECHNISCHE SPECIFICATIES .....	16
15.	MAINTENANCE .....	16
16.	GUARANTEE .....	16
17.	NOTES .....	17

## 5. INTRODUCTION

### 5.1 DESCRIPTION AND APPLICATION OF THE CO2 JET

The CO2 Jet is intended to electronically blow white smoke plumes of CO2 from a distance. As soon as the CO2 leaves the cylinder through the CO2 Jet's secured high-pressure hoses, it converts into gas. This formation of gas is accompanied by a strong hissing sound and a solid white plume of smoke will be visible. The length of this plume is on average 8 metres. This depends on the air humidity: in case of a high degree of air humidity, the smoke plume will be larger and in case of a low degree of air humidity it will be smaller.

The CO2 Jet must be connected to a carbon dioxide (CO<sub>2</sub>) bottle with dip pipe.  
The CO2 Jet is not suitable for other gases than those described above.  
Any use other than that described above will exclude your supplier from any liability.

### 5.2 NECESSARY ACCESSORIES

The following parts belong to the CO2 Jet:

		
<p>Manual</p>	<p>MFX0308 – Shuko – powerCON cable 1.5m</p>	<p>CO<sub>2</sub> Bottle (with dip pipe)</p>
		
<p>High pressure hose 3/8</p>		

Table 5.1

## 6. SAFETY

### 6.1 INTRODUCTION

The CO2 Jet has been designed and constructed in such a manner that it can be used safely. This applies to the use, the circumstances and the regulations as described in this documentation. Reading this documentation and following the instructions are therefore necessary for everyone who is authorised to work with the CO2 Jet.

The CO2 Jet must be placed and used in surroundings that preferably:

- Have a reasonably stable temperature of between 0 and 30°C.
- Have a relative humidity degree of no more than 75%.
- Are reasonably free of dust, corrosive gases and high concentrations of organic vapours.
- Are not situated in the vicinity of a source of vibration.

### 6.2 GENERAL SAFETY RULES



- Only use the CO2 Jet if there are no people, animals or other objects in the direction of the output within the output distance. The shooting direction is the direction in which the output pipe on the CO2 Jet is pointed. The output distance depends on the humidity in the air.
- Make sure that children, unauthorised people and animals do not obtain access to the CO2 Jet!
- Safety devices may not be removed or disabled.
- All required safety devices must be in good condition and function properly.
- Ensure sufficient lighting of the surroundings.
- Keep the workplace clean.
- Only authorised persons may carry out work with the CO2 Jet.

### 6.3 WARNINGS

Warning texts have been attached to the CO2 Jet. With regard to these the following rules apply:

- These texts may not be removed or damaged. The operator must regularly check if this is the case.
- The operator must ensure that the texts are and remain clearly visible and legible.

	<p><b>DANGER WARNING:</b> One must replace texts or signs if these are absent, damaged or illegible.</p>
---	--

Sign and explanation	Photo
 <p>PIC 616 Follow the instructions</p>	
<p>The operator must be told that he/she may only operate the CO2 Jet after reading the user manual.</p> <p>A warning is given for this by means of the command sign of PIC 616. This sign should be attached to the type sign. See also the photo.</p>	



Sign and explanation	Photo
<div data-bbox="395 297 592 465" data-label="Image"> </div> <div data-bbox="363 510 624 544" data-label="Caption"> <p>PIC 307 High voltage</p> </div> <div data-bbox="204 577 778 701" data-label="Text"> <p>A warning must be given about the machine's high voltage by using the caution sign PIC 307. This sign must be attached to the CO2 Jet. See also the added photo.</p> </div>	<div data-bbox="799 264 1401 860" data-label="Image"> </div>

Sign and explanation	Photo
<div data-bbox="379 1014 608 1216" data-label="Image"> </div> <div data-bbox="331 1234 655 1267" data-label="Caption"> <p>PIC 323 Low temperatures</p> </div> <div data-bbox="204 1290 767 1384" data-label="Text"> <p>In case of low temperatures a low temperature warning must be issued by means of warning sign 323.</p> </div> <div data-bbox="204 1413 707 1447" data-label="Text"> <p>This is attached to the top of the CO2 Jet.</p> </div>	<div data-bbox="799 976 1401 1572" data-label="Image"> </div>

## 7. PARTS

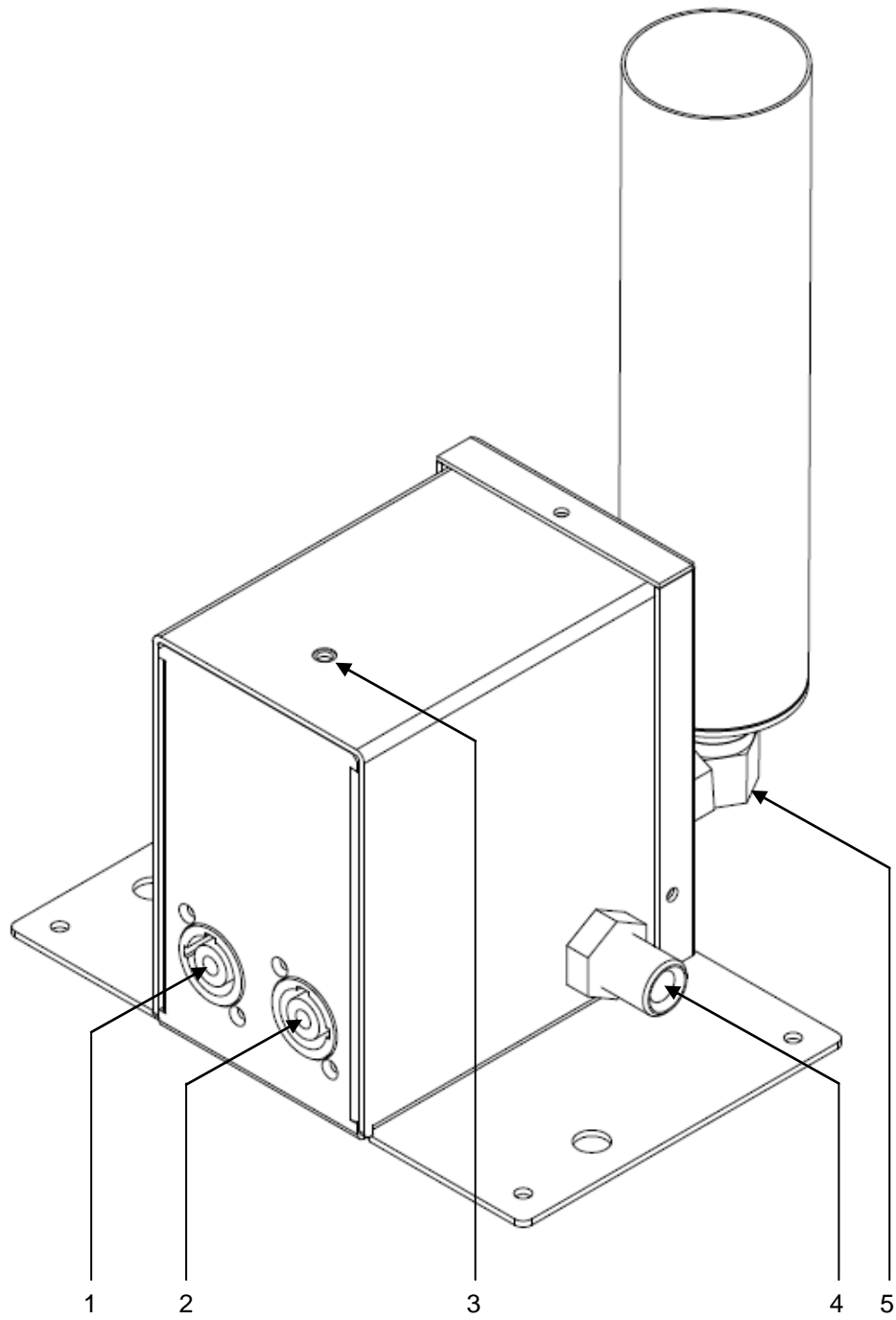

1. powerCON input
2. powerCON output
3. LED indicator
4. CO<sub>2</sub> input
5. CO<sub>2</sub> output

## 8. ACCESSORIES

			
<b>MFX1116 - T-piece (1 bottle – 2 CO2 Jets)</b>	<b>MFX1117 - T-piece (2 bottles – 1 CO2 Jet)</b>	<b>MFX3103 – Twenty clamp M10</b>	
			
<b>MFX1103 – High pressure hose 3/8 - 3m</b>	<b>MFX1106 – High pressure hose 3/8 - 6m</b>	<b>MFX1110 – High pressure hose 3/8 - 10m</b>	<b>MFX1115 – High pressure hose 3/8 - 15m</b>

Table 8.1

You can order these parts and accessories from:



MAGIC FX B.V.  
Schouwrooij 27  
NL-5281 RE BOXTEL  
The Netherlands  
T. +31(0)411 63 50 13  
F. +31(0)411 63 50 12  
W. <http://www.magicfx.eu>  
E. [info@magicfx.eu](mailto:info@magicfx.eu)



## 9. PREPARATIONS

Unpack the CO2 Jet. Dispose of the packaging material without harming the environment. Inspect the machine for any damage. If damage is noticed this must be reported to MAGIC FX.

## 10. INSTALLATION

	<p><b>CAUTION:</b> The machine can be damaged if you do not follow the procedures carefully.</p>
	<p><b>DANGER WARNING:</b> The MAGICFX® CO2 Jet may only be installed by adults and authorised persons.</p>
	<p><b>DANGER WARNING:</b> MAGIC FX is not liable for working with CO2 gas and CO2 bottles or for the correct use thereof.</p> <p>Exclusively use approved CO2 bottles (liquid carbon dioxide with dip pipe) and consult your gas supplier about the installation, instructions, guidelines and regulations for the safe use of the CO2 bottles.</p>

For installing the CO2 Jet work in the following manner:

**1.**

	<p>Place the CO2 Bottle on a stable and even surface and secure it by means of an approved strap or bottle clamp. Place the bottle in such a position that the valve opening does not point in the direction of the public. Place the CO2 bottle preferably outdoors or in a properly ventilated space with a CO2 detection system. The maximum temperature in the surrounding area should be 30°C!</p> <p>Consult your gas supplier for full instructions with regard to CO2 gas use.</p>
--	--

**2.**

	<p>Place the CO2 Jet on a solid and even surface and screw it down (there are 4 screw holes in the base plate). Use 4 screws of a length of at least 5cm and screw them in the holes intended for this in the base plate of the CO2 Jet.</p>
---	--

3.



If required you can adjust the blow pipe to change the direction of the output.

Ensure at all times that the coupling of the blow pipe is firmly tightened with an open-ended spanner.

4.



The CO2 Jet is activated as soon as it is powered by a 230V electricity source. Use a 230V plug and make sure that the electricity is switched off! Now plug the CO2 Jet into the electricity socket.

5.



In order to test, you first need to check if the gas valve on the CO2 bottle is still in a closed position. Now you can check if the CO2 Jet has been installed properly by switching the electricity on and off. If the system has been connected properly you will hear a clicking sound which is produced by the opening and closing of the magnetic valve in the CO2 Jet.

6.



Connect the hose to the CO2 Jet and secure this with, for example, an open-ended spanner (size 22).

7.



**Connect the other end of the hose to a CO2 bottle (with dip pipe).**



Turning it by hand will suffice! You should only use a wrench if the coupling continues to leak.

8.





**When the system is properly connected you can open the valve of the CO2 bottle. Check for leaks.**

**When the gas hose is not properly connected gas can escape. If this is the case then turn the couplings tighter until gas is no longer escaping.**

**The CO2 Jet is now ready for use.**

## 11. USAGE

	<p><b>TIP:</b> Gives you suggestions and advice regarding easier or more convenient ways to carry out certain tasks.</p>
	<p><b>CAUTION:</b> The machine can be damaged, if you do not follow these procedures carefully.</p>
	<p><b>DANGER WARNING:</b> The MAGICFX® CO2 Jet may only be installed by adults and authorised persons.</p> <p>The CO2 Jet may only be operated if all parts are completely and correctly installed/connected.</p>

For using the CO2 Jet take the following steps:

1.

	<p>To operate the CO2 Jet you press the switch on and off. As soon as you press the switch the magnetic valve will immediately open and a white smoke plume will exit from the CO2 Jet. When you press the switch again to the off position the valve will immediately close. Never switch for more than 3 seconds. This way you prevent dry ice from forming on the blow pipe and you will not cause an accumulation of CO2 in the room.</p>
--	---



	<p>The CO2 Jet can be operated by means of DMX. To this end use a DMX FX Switchpack.</p> <p> Ensure that you always have the CO2 Jet in clear sight.</p>
---	---

## 12. SWITCHING OFF

To switch off the CO2 Jet, take the following steps:

1.



Close the valves of the gas bottle.

2.



Activate the CO2 Jet one more time to remove the remaining pressure from the hose.

3.



Disconnect the plug(s) of the CO2 Jet from the power supply.

4.



Only when there is no more gas in the hose can the hose be disconnected from the gas bottle and the CO2 Jet.



### 13. TROUBLESHOOTING

- **The CO2 Jet is leaking**

Check if the coupling of the gas hose is connected properly to the coupling of the CO2 Jet. If it is not entirely secured then press it firmly. This is only possible when there is no pressure on the hose. If the problem persists, then consult the technical service of MAGIC FX.

- **Only a small smoke plume is visible when the CO2 gas exits the CO2 Jet.**

Visibility can vary due to air humidity. The output will be more visible when there is high absolute air humidity.

- **There is no white smoke plume visible when the CO2 gas exits the CO2 Jet.**

You may not have the right carbon dioxide cylinders. Connect bottles with liquid carbon dioxide and a dip pipe to the CO2 Jet.

In some cases the dip pipe may be broken. In that case replace the carbon dioxide bottle with another and inform your gas supplier about the cylinder with the defective dip pipe.

- **The CO2 Jet is still malfunctioning after troubleshooting**

Always contact your dealer or the technical service of MAGIC FX first in case of uncertainties, questions about the CO2 Jet works or other issues with regard to the CO2 Jet.

### 14. TECHNISCHE SPECIFICATIES

Measurements and weight	Length:	195mm (12.2")
	Width:	150mm (14.96")
	Height:	130mm (11.61")
	Weight:	2.85 Kg (21.5lbs.)
Power	Input:	AC 230V~50-60Hz
	Usage:	AC 230V~50-60Hz
	Fuse:	20W
CO <sub>2</sub>	Input:	Liquid CO <sub>2</sub>
	Output:	CO <sub>2</sub> Gas
	Usage:	0.5 Kg/s (1.1 lbs./s)
	Quick Connector:	RU 1 (W21.8x1/14") – 3/8" BSP

Design and product specifications can be changed without prior notification.

### 15. MAINTENANCE

To achieve the maximum service life of the CO2 Jet you must regularly clean the CO2 Jet and test if it is working correctly.

Should the CO2 Jet not work for some reason then please contact MAGIC FX.

	<p><b>DANGER WARNING:</b> Do not replace parts yourself; always consult MAGIC FX if necessary.</p>
---	--

### 16. GUARANTEE

A manufacturer's guarantee of 3 years applies to the MAGIC FX CO2 Jet.

- The guarantee expires if the CO2 Jet is used for improper purposes and for applications which are not stated in this manual.
- The guarantee also expires if the machine is used incorrectly or in violation of the regulations.
- The guarantee expires if the machine is altered without permission from the supplier.



